

ATEX Type Certification marking for type L1X-EX, T1X-EX, T2X-EX

Type of protection "d" explosion-proof enclosure

Approval:

 II 2 G D
Ex d IIC T6
Ex tD A21 IP65 T80°C
-40°C ≤ Tamb ≤ +75°C

Certificate no.:

ISSEP08ATE024X

Standards applied:

IEC 60079-0, IEC60079-1, IEC 61241-0 and
IEC 61241-1

L1X, T1X, T2X Models are UL (File No. E58658, Guide No. XBDV) & CSA (File No. LR34556, Guide 400-E, Class 4868) are Listed as Temperature Indicating and Regulating Equipment for use in Hazardous Locations, as follows;
Class I, Groups B (UL Only), C & D, Class II, Groups E, F & G, Class III.

ML1H, MT1H, L2H, T2H Models are UL (File No. E56247) & CSA (File No. LR34555, Guide 400-E-O, Class 4813) are Listed as Temperature Indicating and Regulating Equipment for use in Ordinary Locations.

Operating life time

The switches are designed for an operating life time of at least 1 million cycles when used under normal design criteria.

**Operating Instructions Mechanical Temperature Switches
ML1H,MT1H,L2H,T2H,L1X/L1X-EX,T1X/T1X-EX,T2X/T2X-EX**



1	Intended Applications	2
2	Safety Instructions	2
3	Standards	3
4	Warranty/Guaranty	3
5	Transport/Storage	3
6	Installation/Commissioning.....	4
7	Maintenance/Cleaning.....	8
8	Technical Data	8

Barksdale, Inc.
3211 Fruitland, Ave.
Los Angeles, CA 90058

Phone: 800 835-1060
Fax: 323 589-3463
email: sales@barksdale.com
Internet: www.barksdale.com

Bulletin No. 272182-E
Date: 07-20-2009



Specifications are subject to changes
without notice!

Intended Applications

The temperature switches are specifically applied for monitoring and controlling of operations using maximum or minimum temperatures. A micro switch triggers an electrical signal when minimum or maximum temperatures are reached.

 DANGER
The switch may only be used in the specified fields of application (see type label).
The temperature has to be within the specified ranges, the pressure values and the electrical rating must not exceed the values specified.
Observe also the applicable national safety instructions for assembly, commissioning and operation of the switch.
The switch is not designed to be used as the only safety relevant element in pressurized systems according to DGR 97/23/EC.

Safety Instructions

The safety instructions are intended to protect the user from dangerous situations and/or material damage.

In the operating instructions the seriousness of the potential risk is designated by the following signal words:

 DANGER
Refers to imminent danger to men. Non-observance may result in fatal injuries.

 WARNING
Refers to a recognizable danger. Non-observance may result in fatal injuries, and destroy the equipment or plant parts.

 CAUTION
Refers to a danger. Non-observance may result in light injuries and material damage to the equipment and/or to the plant.

Local mount temperature switches

Measuring Ranges

Order code	Max. temperature at sensor	Adjustment range
	[°F]	[°F]
201	-100... +250	-49... +75.2
202	-100... +250	15.8... +140
203	-100... +250	75.2... +200
351	-100... +401	100...+244.6
204	-100... +200	-49... +200
354	-100... +401	100...+350.6
454	-0.4... +500	150.8...+449.6

Reset values

Order code	Adjustment range	Approximate hysteresis of different types of micro switches				
	[°F]	GH, H	J	M	S adjustable from	G*
201...354	-49...+350.6	1 – 2.8	2.2 - 4	1 - 4	6 - 20	5.0
454	150.8...+449.6	2.8 - 6	2.8 - 5	4 - 6.8	10 - 30	5.0

* can be reset

 IMPORTANT
The values given are for use in liquids. For gaseous media hysteresis will be approx. double the values.

Measuring Ranges

Order code	Max. temperature at sensor [°F]	Adjustment range [°F]
154	-100... +200	-49... +151
251	-100... +300	50... +250
351	-100... +401	151... +350
601	-0.4... +650	300... +440
603	-0.4... +650	320... +600

Temperature switch with remote sensor

Reset values

Order code	Adjustment range [°F]	Approximate hysteresis of different types of micro switches				
		GH, H	J	M	S adjustable from to	G*
154	-49... +151	1 - 2	1 - 3.4	1 - 4	4 - 14.7	5.0
251	50... +250	1 - 2	1 - 3.4	1 - 4	4 - 14.7	5.0
351	151... +350	1 - 2	1 - 3.4	1 - 4	4 - 14.7	5.0
601...603	-0.4... +600	2 - 4	2.8 - 5	4 - 6	6.8 - 24.8	5.0

* can be reset

 IMPORTANT
The values given are for use in liquids. For gaseous media hysteresis will be approx. double the values.

 IMPORTANT
Refers to important information essential to the user.

 Disposal
The equipment must be disposed of correctly in accordance with the local regulations for electric/electronic equipment. The equipment must not be disposed of with the household garbage!

Standards

The standards applied during development, manufacture and configuration are listed in the CE conformity and manufacturer's declaration.

Warranty/Guaranty

Warranty

Our scope of delivery and services is governed by the legal warranties and warranty periods.

Terms of guaranty

We guaranty for function and material of the single / dual temperature switch under normal operating and maintenance conditions in accordance with the statutory provisions.

Loss of guaranty

The agreed guaranty period will expire in case of:

- changes or modifications to the housing/switch/fitting
- incorrect use,
- incorrect installation or
- incorrect handling or operation contrary to the provisions of these operating instructions.

No liability is assumed for any damage resulting therefrom, or any consequential damage.

Transport/Storage

 CAUTION
Severe shock and vibrations should be avoided during transport. Storage should be dry and clean.

Installation/Commissioning

 **DANGER**

Only install or uninstall the switch when de-energized (electrically and hydraulically/pneumatically).
Process connection and electrical connection must be carried out by trained or instructed personnel according to state-of-the-art standards.
The switch must only be installed in systems where the maximum temperature T_{max} is not exceeded (see type label).

 **WARNING**

Be aware of the fact that in case of operation with higher temperatures the casing surface may become very hot!
Ambient temperature range: -40... +75 °C; max. pressure at sensor: 21 bar

 **WARNING**

In case the temperature falls below or exceeds the permissible temperature limits specified for the sensor and the permissible ambient temperature, the function of the temperature switch can no longer be guaranteed and the temperature switch may be damaged.
Check the operation of the switch regularly. If the switch does not work properly, stop operation immediately!

 **CAUTION**

All standard temperature switches are supplied with conduit threads which must be sealed with pipe sealant or Teflon tape to prevent moisture entry. The explosion-proof switches have threaded plugs covering the electrical connection entry.
Threaded plugs must be removed to install the approved electrical connection of your choice. The capillary system must be installed with care avoiding sharp bends. Provide protection against damage where needed.

 **IMPORTANT**

The temperature sensing element can be used up to 21 bar. In case of pressures higher than 21 bar the temperature sensing element must be provided with a thermowell suitable for the respective application.
All temperature switches are tested for proper functioning before they leave the factory.

Electrical Ratings

Micro switch	Special Characteristics	Volt AC 50/60 Hz	Ind. Load A	Res. Load A	Volt DC	Ind. Load A	Res. Load A	Notes
H	Micro switch with silver contacts	125 250 480	10 10 3	10 10 3	6 to 24	0.50	0.5	Small hysteresis; high AC / low DC loads
M	Micro switch with silver contacts	125 250 480	10 10 3	10 10 3	12 24 250	5.00 1.00 0.25	15.0 2.0 0.4	Medium hysteresis; high AC and DC loads
GH	Micro switch with gold plated contacts for low voltage and low current	125	1	1	24	1.00	1.00	Small hysteresis
S	Micro switch with silver contacts	125 250 480	15 15 15	15 15 15	12 24 250	10.00 5.00 0.03	15.0 6.0 0.2	Adjustable hysteresis
J	Micro switch - sealed - with silver contacts	125 250 480	10 10 3	10 10 3	6 to 24	0.50	0.5	Small hysteresis
G...RD	Micro switch with silver contacts	125 250 480	10 10 10	10 10 10	12 24 250	15.00 10.00 0.20	15.0 15.0 0.3	Manual reset

We recommend gold plated contacts for all applications with low voltage/power.

 **IMPORTANT**

Data only valid for application in non-explosive atmosphere.
We recommend use of a pre-fuse of the maximum current rating from the table above according to the load switched.

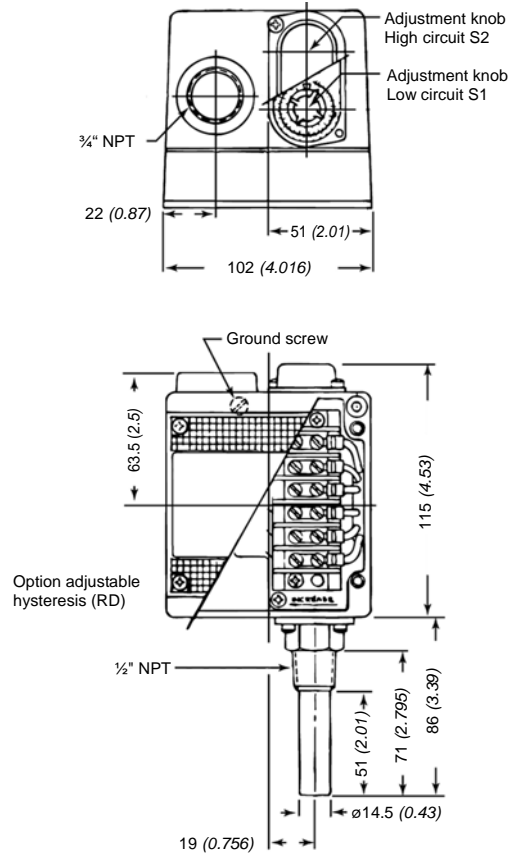

Contacts: color code and function

	Lower contacts	Upper contacts
C = Common	= purple	C = brown
NC = Normally Closed Contact	= blue	NC = orange
NO = Normally Open Contact	= red	NO = yellow

Fig. 11: Temperature switch type L2H-...

Contact Protection

The micro switches used are normally suitable for both direct and alternating current operation. Inductive, capacitive and lamp loads may, however, considerably reduce the life expectancy of a micro switch and, under extreme circumstances, even damage the contacts.

Depending on the application spark suppression and current limiting is recommended (see succeeding figures).

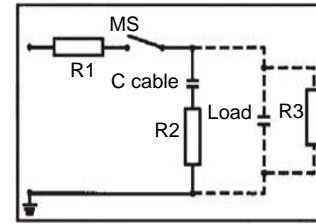

Fig. 1: Protection in case of capacitive loads
R1: Protection against starting current rushes
R2, R3: Protection against high discharge currents

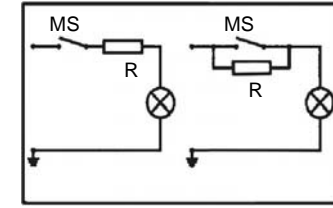

Fig. 2: Lamp load provided with resistance in series or parallel connection to switch of condensers

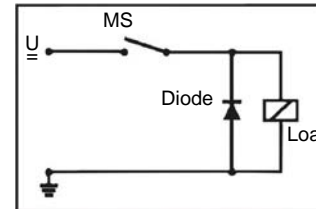

Fig. 3: Protection in case of continuous current and inductive load by recovery diode

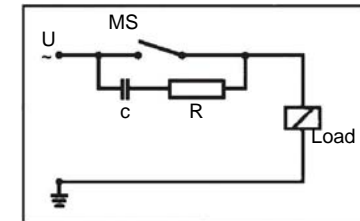



Fig. 4: Protection in case of alternating current and inductive load by RC-link

Set point adjustment

In temperature switches, the liquid expands in the sensing element (capillary) when the temperature changes. Due to the expansion the micro switch is actuated.

Upon delivery of the product, the set points are likely to be found in the middle of the adjustable range. On request, fix set points may be adjusted by our factory. In this event, the point will be indicated on the type plate or any separate plate, i = increasing, d = decreasing.

The set point is adjusted by turning the adjustment knob. (Knob visual indication is for reference only).

	IMPORTANT
In some cases the corresponding housing cover must be removed in order to reach the adjustment knob.	

Heat the temperature switch to the desired switching temperature.

Turn the adjustment knob to actuate the micro switch. (Knob visual indication is for reference only)

	IMPORTANT
Please consult the wiring diagram for the contact status at state of rest (see Fig. 5).	

Precise adjustment of set point to actuate on increasing temperature

Connect a control unit (lamp, buzzer, etc.) to (C) and (NO). When the unit is connected correctly and the sensor temperature is higher than the temperature adjusted on the scale, the buzzer or lamp is **not** activated.

Adjust the desired switch point with the help of the scale via the adjustment knob. (Knob visual indication is for reference only).

Watch the switch point while the temperature is rising (about 2°C/minute). The control unit is activated when the switch point is reached.

If necessary, re-adjust the set temperature by some degrees (by means of the scale the temperature can be adjusted with an accuracy of 3...5 % of the scale value).

Precise adjustment of set point to actuate on decreasing temperature

Connect a control unit (lamp, buzzer, etc.) to (C) and (NC). When the unit is connected correctly and the sensor temperature is higher than the temperature adjusted on the scale, the buzzer or lamp is activated.

Adjust the desired switch point with the help of the scale via the adjustment knob. (Knob visual indication is for reference only).

Increase the temperature (about 2°C/minute) until the control unit is deactivated.

Watch the point at which the control unit is activated again while the temperature is falling. This is the set switch point.

If necessary, readjust the set temperature by some degrees (by means of the scale the temperature can be adjusted with an accuracy of 3...5 % of the scale value).

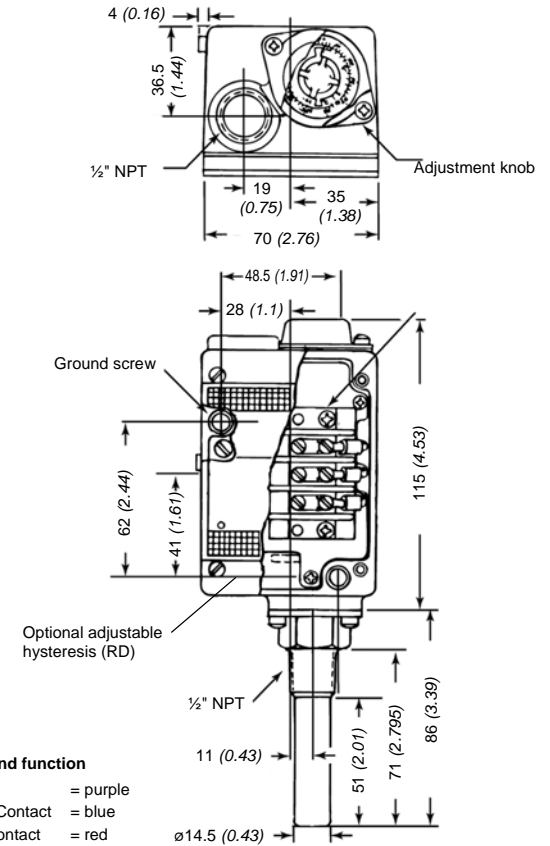
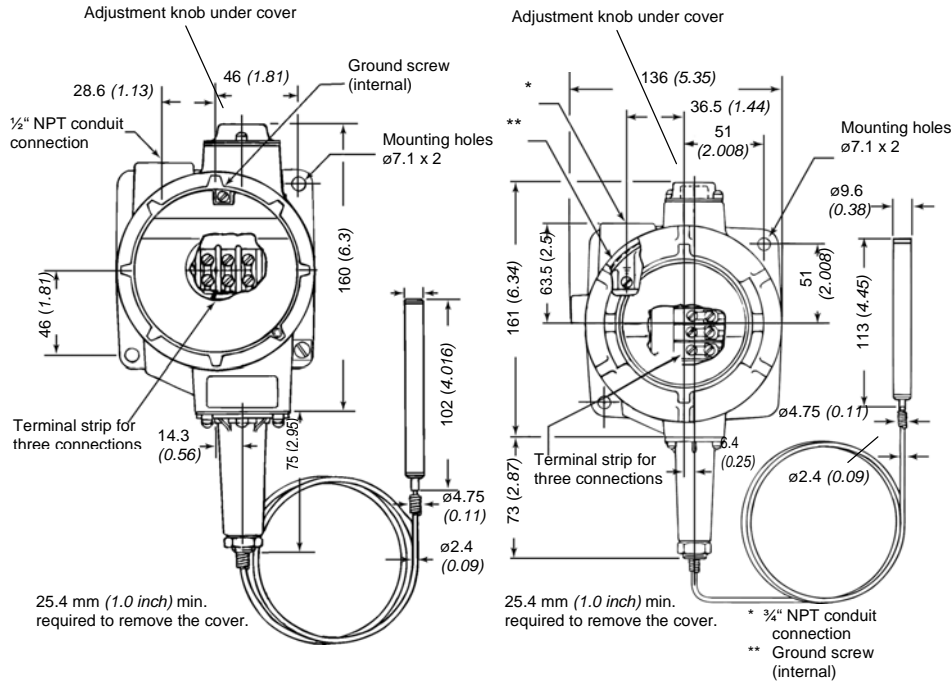

Fig. 10: Temperature switch type ML1H...



Contacts: color code and function

Contacts	Contacts
C = Common	= purple
NC = Normally Closed Contact	= blue
NO = Normally Open Contact	= red

Contacts: color code and function

Lower contacts	Upper contacts
C = Common	= purple
C = Common	= brown
NC = Normally Closed Contact	= blue
NC = Normally Closed Contact	= orange
NO = Normally Open Contact	= red
NO = Normally Open Contact	= yellow

Fig. 8: Temperature switch type T1X-.../T1X-EX... Fig. 9: Temperature switch type T2X-.../T2X-EX...

IMPORTANT

Adjustment of several set points is performed for each set point as specified above.

Due to the sluggishness of the capillary system switching delays may occur in case of rapid temperature changes (>2 °C/Minute).

Wiring Code for all Types (Contact status at atm. pressure)

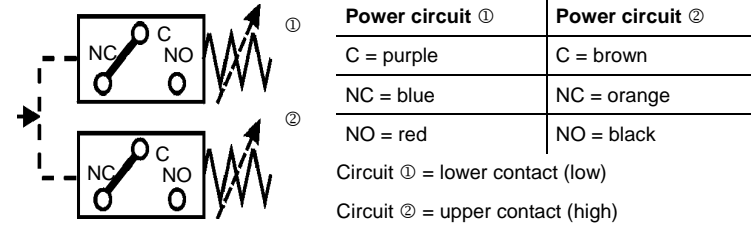

Fig. 5 Wiring Code

Use in Hazardous Locations

The weather-proof standard temperature switches must not be used for hazardous locations. Special temperature switch types; T1X-EX, T2X-EX and L1X-EX for Ex d IIC T6 explosion-proof applications with Certificate No. ISSeP 08 ATEX 024X.

These special models are suitable for gas and dust applications and approved for Ex II G D in accordance with the ATEX 94/9/EC regulations.

These special switches with explosion-proof enclosure must be wired with Ex Certified conduit connection, or cable gland. The switches may only be used in accordance with the instructions and provisions of the declaration of conformity.

